

TCL

X937U

7.1.4 Channel Soundbar with RayDanz / Play-Fi / Dolby Atmos / DTS:X

Quick Start Guide



English | Albanian | Bulgarian | Croatian | Czech | Danish | Dutch | Estonian | Finnish | French | German | Greek | Hungarian | Italian | Latvian | Lithuanian | Macedonian | Norwegian | Polish | Portuguese | Romanian | Russian | Serbian | Slovak | Slovene | Spanish | Swedish | Turkish | Ukrainian



EN Make sure you read all the safety information before you use this product.

SQ Sigurohuni që të lexoni të gjithë informacionin e sigurisë përpara se të përdorni produktin.

BG Преди да използвате продукта, задължително прочетете всички инструкции за безопасност.

HR Obavezno pročitajte sve sigurnosne informacije prije korištenja ovog proizvoda.

CS Před použitím tohoto výrobku si přečtěte všechny bezpečnostní informace.

DA Læs alle sikkerhedsoplysninger, før du bruger produktet.

NL Zorg ervoor dat u alle veiligheidsinformatie leest voordat u dit apparaat gebruikt.

ET Enne seadme kasutamist lugege kindlasti kõiki ohutuseskirju.

FI Lue kaikki turvallisuusohjeet ennen tuotteen käyttöä.

FR Assurez-vous d'avoir lu toutes les informations relatives à la sécurité avant d'utiliser cet appareil.

DE Vergewissern Sie sich, dass Sie sämtliche Sicherheitshinweise gelesen haben, bevor Sie dieses Produkt verwenden.

EL Βεβαιωθείτε ότι έχετε διαβάσει όλες τις πληροφορίες ασφαλείας πριν χρησιμοποιήσετε αυτό το προϊόν.

HU A készülék használatba vétele előtt olvassa el az összes biztonsági előírást.

IT Assicurarsi di aver letto tutte le informazioni sulla sicurezza prima di utilizzare questo prodotto.

LV Pirms produkta lietošanas noteikti izlasiet visu drošības informāciju.

LT Prieš pradėjami naudoti šį gaminį, būtinai perskaitykite visus saugos nurodymus.

MK Погрижете се да ги прочитате сите безбедносни информации пред да го користите овој производ.

NO Sorg for å lese alle sikkerhetsinstruksjonene før du bruker produktet.

PL Przed użyciem produktu należy dokładnie przeczytać wszystkie wskazówki dotyczące bezpieczeństwa.

PT Certifique-se de ler todas as informações de segurança antes de usar este produto.

RO Asigurați-vă că ați citit toate informațiile de siguranță înainte de a utiliza acest produs.

RU Прежде чем приступить к эксплуатации устройства, прочтите все инструкции по безопасности.

SR Obavezno pročitajte sve informacije o bezbednosti pre upotrebe ovog proizvoda.

SK Pred použitím tohoto produktu si prečítajte všetky bezpečnostné informácie.

SL Zagotovite, da ste pred uporabo tega izdelka prebrali vse varnostne informacije.

ES Asegúrese de leer toda la información de seguridad antes de utilizar este producto.

SV Se till att du läser all säkerhetsinformation innan du använder produkten.

TR Bu ürünü kullanmadan önce tüm güvenlik bilgilerini okuduğunuzdan emin olun.

UA Уважно ознайомтеся із усією інформацією стосовно техніки безпеки перед використанням пристрою.

A



B

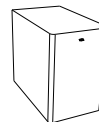

C



D x 2



E x 2



F



G

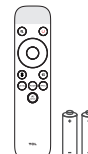

H

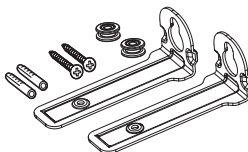

I

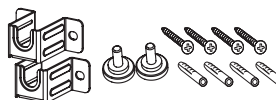

J

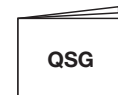

K

Safety
instructions

L

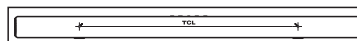

M

Warranty
card

2a



A

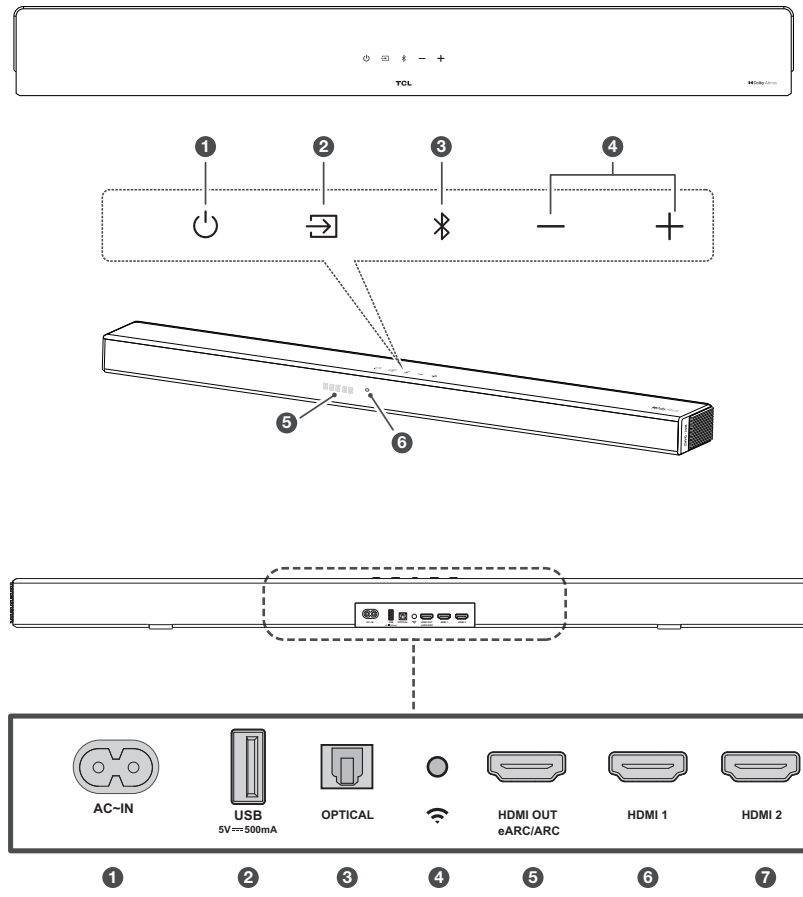

2b

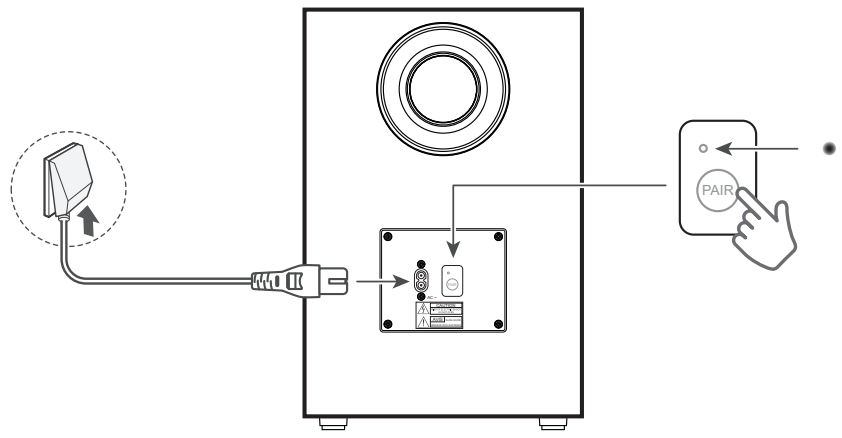

2c

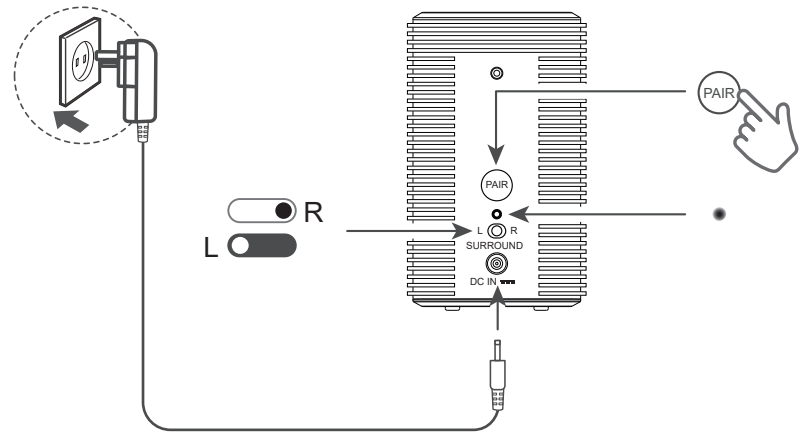

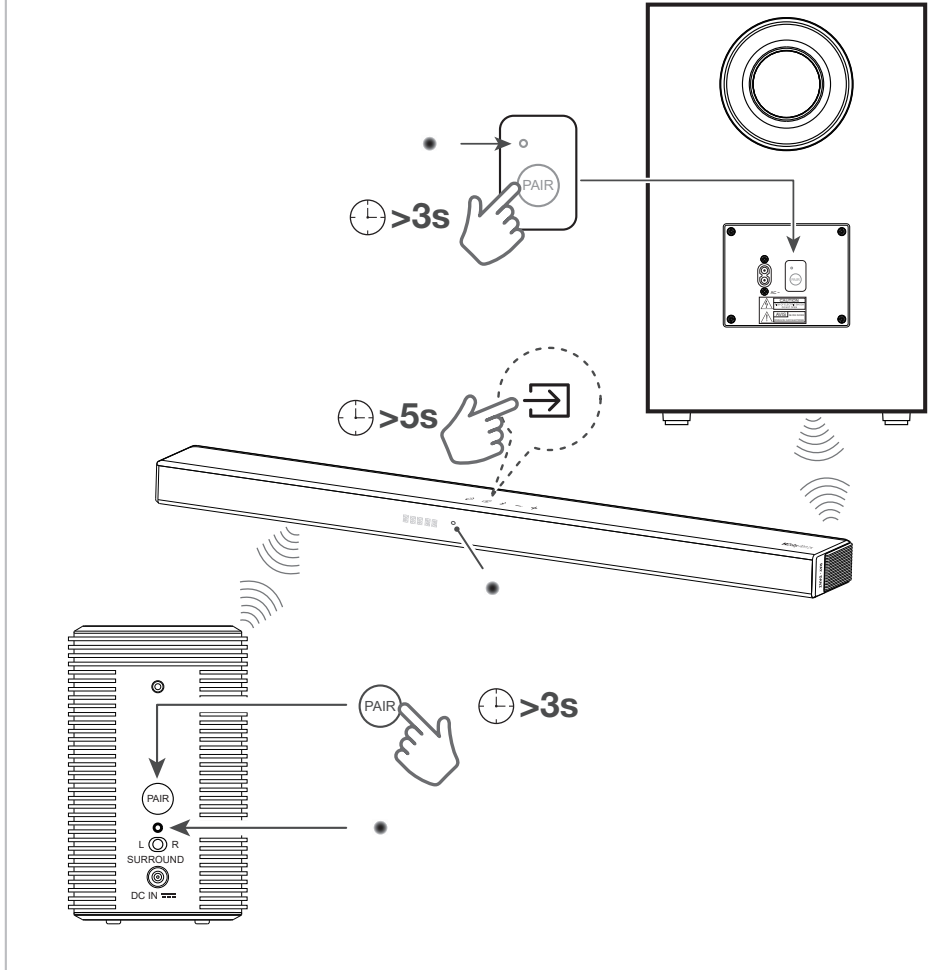

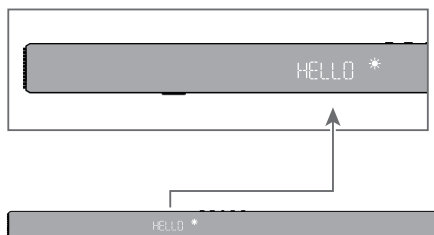

FR

	État de la barre de son	État d'affichage LED
Alimentation	Mise sous tension	HELLO
	Mise hors tension	STDBY / SLEEP
Source	HDMI eARC/ARC	ARC / eARC
	Optique	OPT
	USB	USB
	Bluetooth	BT
	HDMI 1	HDMI1
	HDMI 2	HDMI2
Bluetooth	Mode de recherche (clignotant)	BT
	Mode d'appairage	PAIR
Contrôle du volume	Niveau de volume	V 36
	Volume minimal atteint	MIN
	Volume maximal atteint	MAX
	Muet	MUTE
Niveau	BASSE (+/-)	BAS-S / BAS+S
	AIGUS (+/-)	TRE-S / TRE+S
	Volume renforcé (+/-)	SR-S / SR+S
	Dialogue	DIAL0 / DIAL6
	Sync Av	SYNC
Modes sonores	Standard/Voix/Musique/ Film/Jeu/Sports	STANDARD VOICE MUSIC MOVIE GAME SPORT
	Basse renforcée	BASBST ON / BASBST OFF
Effet sonore	Surround renforcé	SURENH ON / SURENH OFF
	Passer	PASSTH ON / PASSTH OFF
	Nuit	NIGHT ON / NIGHT OFF
	NEURALX	DTSNEU ON / DTSNEU OFF
	DRC	DTSBRC LOW / DTSBRC MID / DTSBRC HIGH
	LED DIM	DIM 1 / DIM 2 / DIM 3

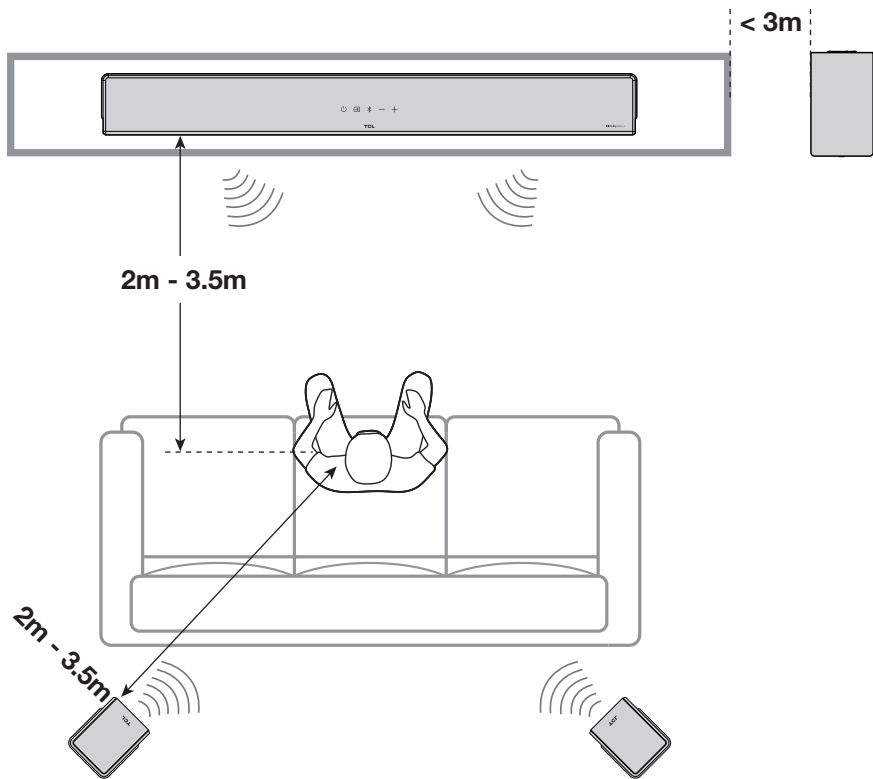

5a



L

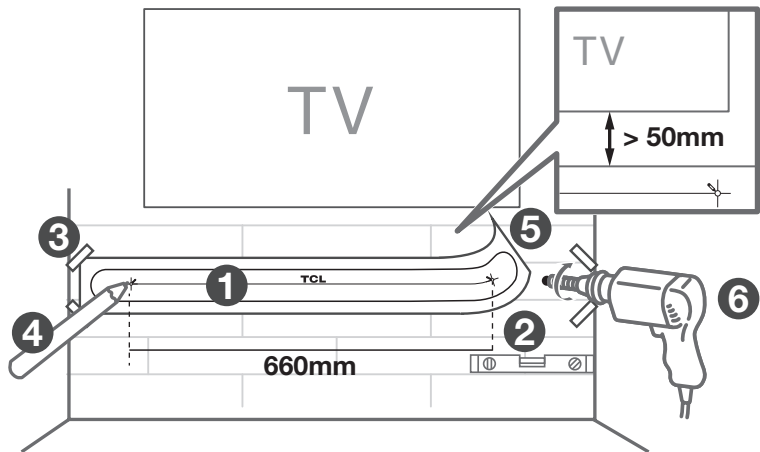
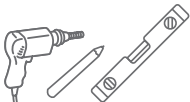
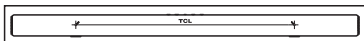

5b



H

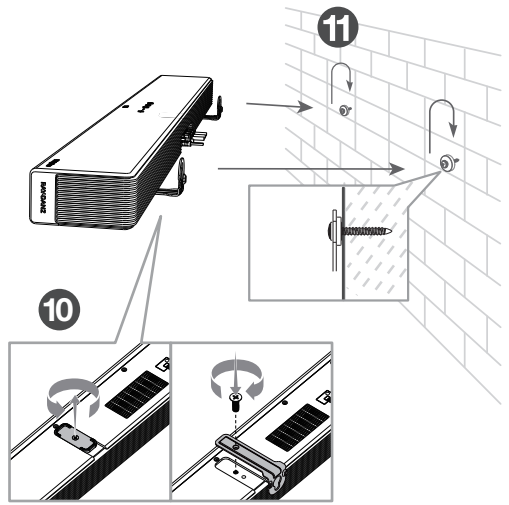
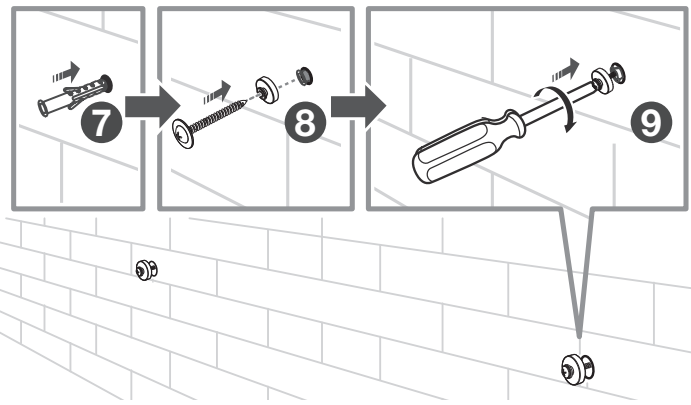
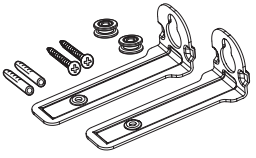

5c



I

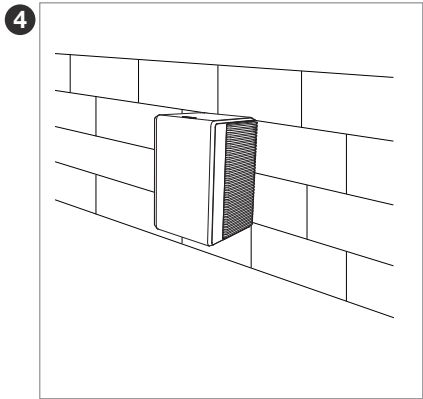
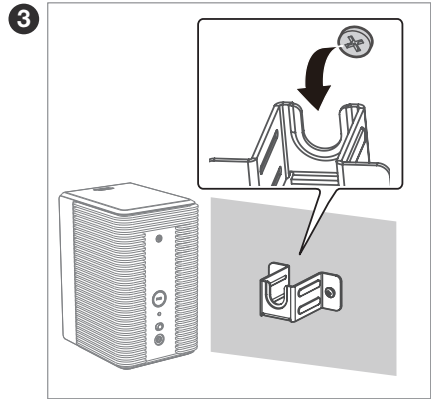
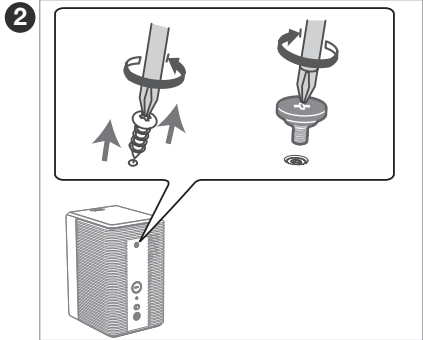
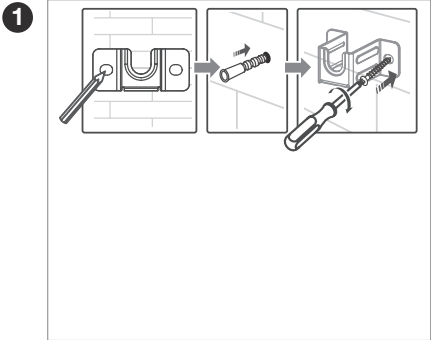

6a



Type de batterie : Batterie AAA 1,5V x 2

G

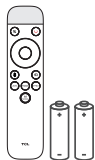

! Avertissement : N'exposez pas les piles à une chaleur excessive, telle que le soleil, le feu, etc.). Conservez les piles neuves et usagées hors de portée des enfants. Veuillez contacter les autorités locales pour des informations sur la mise au rebut ou le recyclage.

! ATTENTION : Risque d'explosion si les piles sont incorrectement remplacées. Remplacez exclusivement par les piles de type similaire ou équivalent.

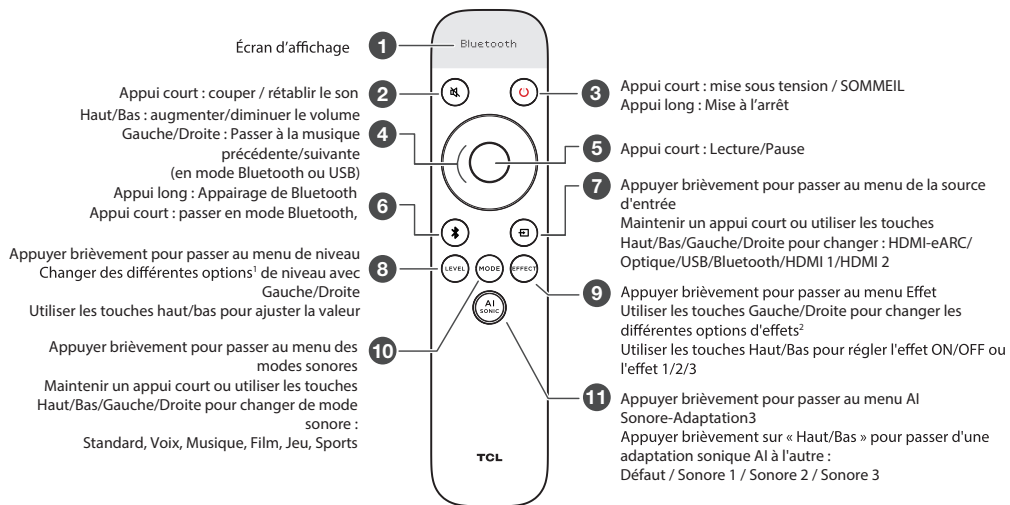
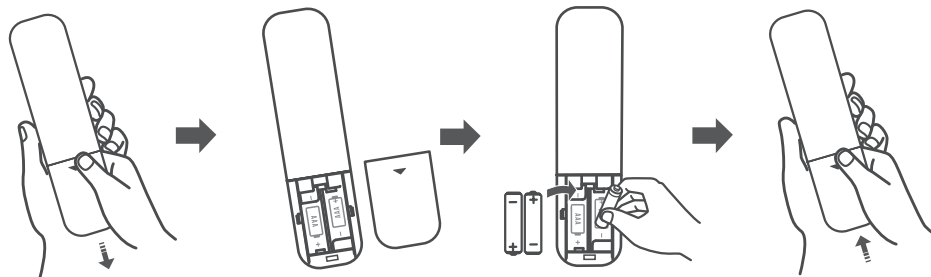

1. Options de niveau : Bass, Treble, Dialogue, SurrVol, Av Sync.

2. Options d'effets : Bass Boost, Surround Enhance, Pass through, Night, NEURALX, DRC, LED Dim.

3. Adaptation AI-Sonic : Voir la section 8 pour plus de détails.

Remarque :

Mode usine : Appuyer longuement sur Mode+Muet en même temps pendant 5 secondes.

7a



F

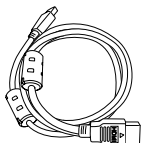

- EN** The most preferred connection options:
SQ Opsionet më të preferuara të lidhjes janë:
BG Препоръчителни варианти за свързване:
HR Najpoželjnije mogućnosti povezivanja:
CS Nejvhodnější možnosti připojení:
DA Foretrukne tilslutninger:
NL De meest geprefereerde verbindingsopties:
ET Kõige eelistatumad ühendused:
FI Suosituin yhteysvaihtohto:
FR Connexions à privilégier :
DE Die beliebtesten Anschlussarten:
EL Οι πιο προτιμώμενες επιλογές σύνδεσης:
HU A leginkább javasolt csatlakoztatási lehetőségek:
IT Le opzioni di collegamento preferite:
LV Ieteicamās savienojumu opcijas:
LT Priimtinausias ryšio galimybės:
MK Препорочитани опции за поврзување:
NO Tilkoblingsvalgene som oftest foretrekkes:
PL Najbardziejziej preferowane opcje połączeń:
PT As opções de ligação mais comuns:
RO Cele mai preferate opțiuni de conectare:
RU Предпочтительные варианты подключения:
SR Najpoželjniji načini povezivanja:
SK Najpreferovanejšie možnosti pripojenia:
SL Najbolj prijubljene možnosti povezave:
ES Opciones de conexión preferidas:
SV De mest föredragna anslutningsalternativen:
TR En çok kullanılan bağlantılar:
UA Найкращі опції з'єднання:

1) HDMI (ARC); 2) Optical

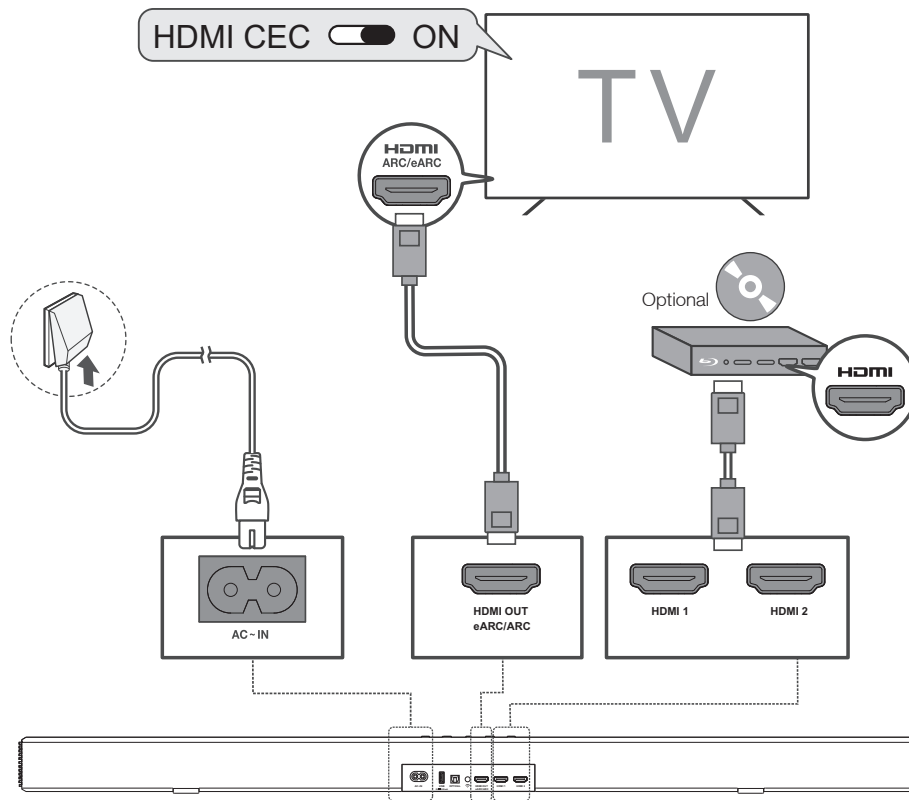

7a



F

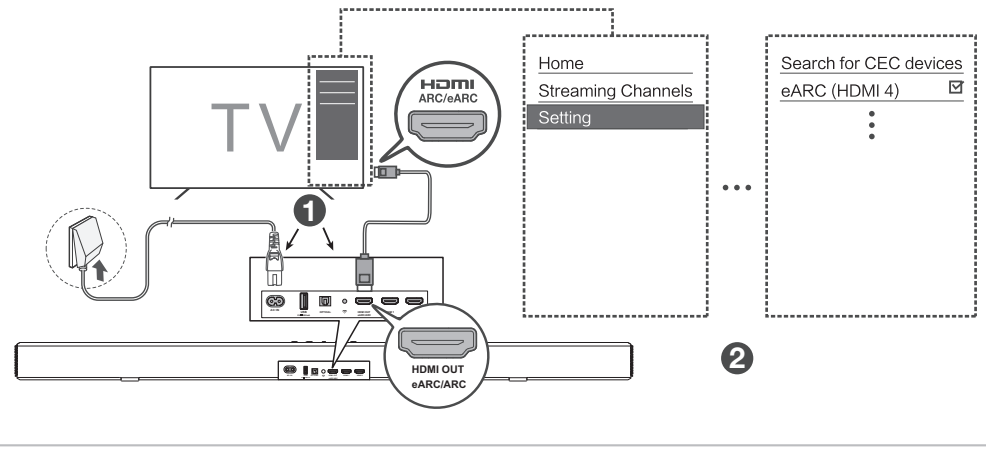
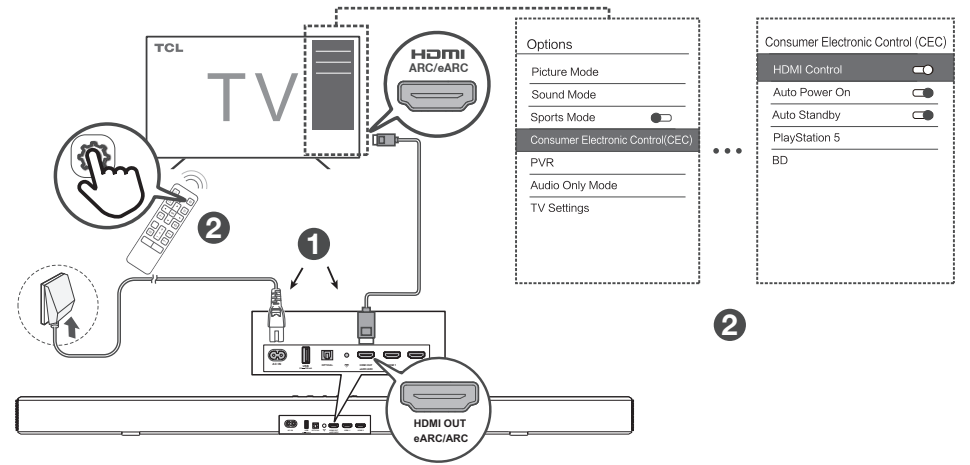



- EN** This cable is sold seperately.
SQ Ky kabëll shitet veçmas.
BG Този кабел се продава отделно.
HR Ovaj se kabel prodaje zasebno.
CS Tento kabel se prodává samostatně.
DA Dette kabel sælges separat.
NL Deze kabel wordt apart verkocht.
ET Seda kaablit müüakse eraldi.
FI Kaapeli myydään erikseen.
FR Ce câble est vendu séparément.
DE Dieses Kabel wird separat verkauft.
EL Αυτό το καλώδιο πωλείται ξεχωριστά.
HU Ezt a kábelt külön értékesítik.
IT Questo cavo è venduto separatamente.
LV Šis kabelis tiek pārdots atsevišķi.
LT Šis kabelis parduodamas atskirai.
MK Овој кабел се продава одделно.
NO Denne kabelen selges separat.
PL Ten kabel jest sprzedawany osobno.
PT Este cabo é vendido separadamente.
RO Acest cablu este vândut separat.
RU Этот кабель продается отдельно.
SR Ovaj kabel se prodaje odvojeno.
SK Tento kábel sa predáva osobitne.
SL Ta kabel se prodaja ločeno.
ES Este cable se vende separadamente.
SV Denna kabel säljs separat.
TR Bu kablo ayrı satılır.
UA Цей кабель продається окремо.

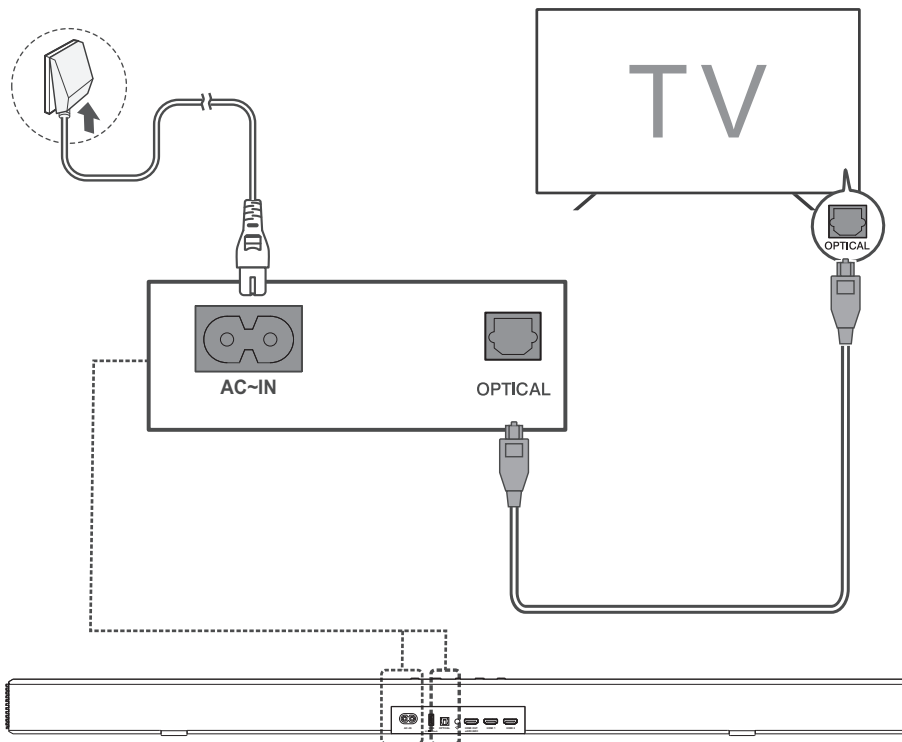

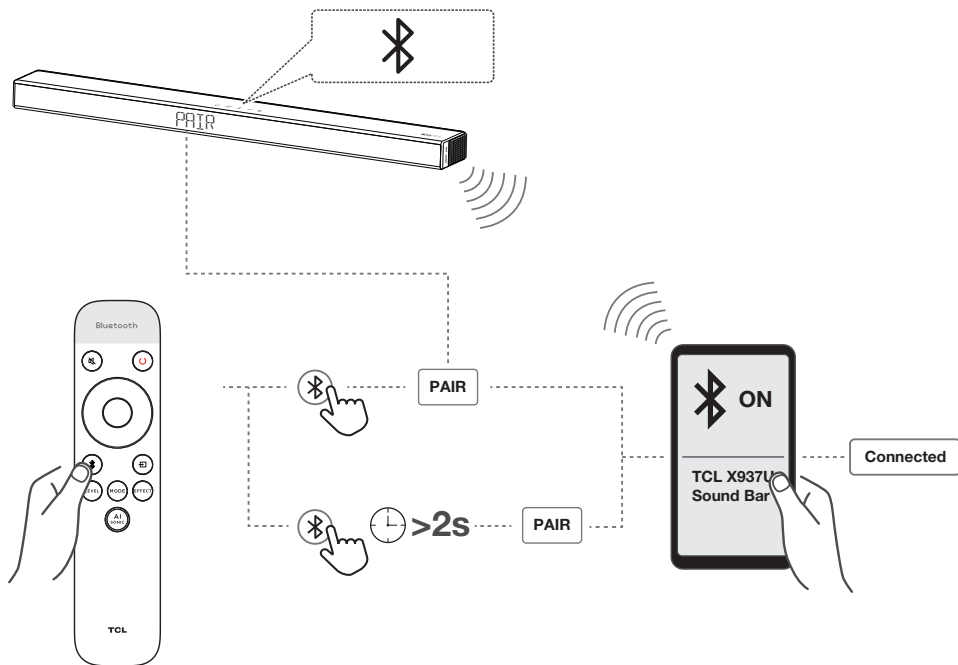

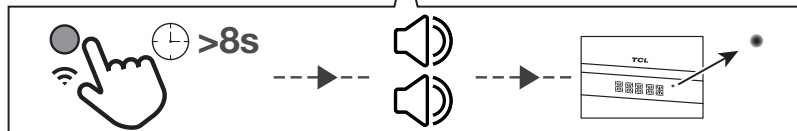

iOS



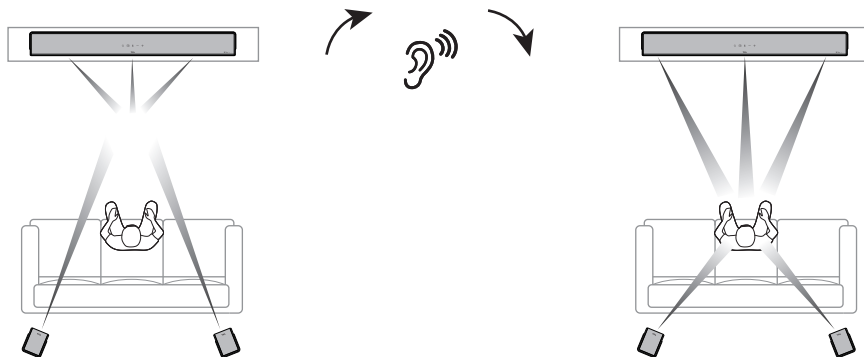
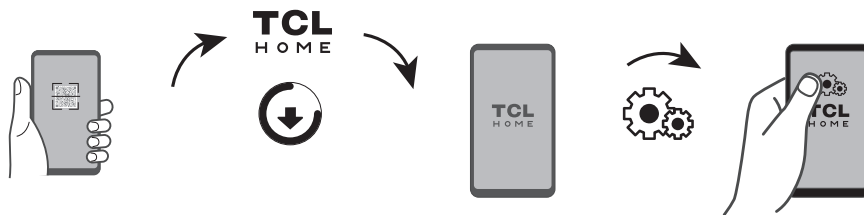

Trademarks



To control this AirPlay 2-enabled speaker, iOS 11.4 or later is required. Apple, AirPlay, iPad, iPad Air, iPad Pro, and iPhone are trademarks of Apple Inc., registered in the U.S. and other countries.



Use your phone, tablet or computer as a remote control for Spotify. Go to spotify.com/connect to learn how. The Spotify Software is subject to third party licenses found here: www.spotify.com/connect/third-party-licenses.



Google and Chromecast built-in are trademarks of Google LLC.



Google and works with Ok Google are trademarks of Google LLC.



Amazon, Alexa and all related logos are trademarks of Amazon.com, Inc. or its affiliates.

COMPATIBLE WITH



Dolby, Dolby Atmos, Dolby Vision, and the double-D symbol are registered trademarks of Dolby Laboratories Licensing Corporation. Manufactured under license from Dolby Laboratories. Confidential unpublished works. Copyright © 2012-2022 Dolby Laboratories. All rights reserved.



The Bluetooth® word mark and logos are registered trademarks owned by Bluetooth SIG, Inc. and any use of such marks by TTE Corporation is under license. Other trademarks and trade names are those of their respective owners.



For DTS patents, see <http://patents.dts.com>. Manufactured under license from DTS, Inc. (for companies headquartered in the U.S./Japan/Taiwan) or under license from DTS Licensing Limited (for all other companies). DTS, DTS:X, the DTS:X logo, DTS, DTS Play-Fi, Play-Fi and the DTS Play-Fi and Play-Fi logos are registered trademarks or trademarks of DTS, Inc. in the United States and other countries. © 2022 DTS, Inc. ALL RIGHTS RESERVED.



The Adopted Trademarks HDMI, HDMI High-Definition Multimedia Interface, HDMI trade dress and the HDMI Logos are trademarks or registered trademarks of HDMI Licensing Administrator, Inc. in the United States and other countries.

**WE ARE
READY TO
HELP** contact us first
with any questions



TCL SUPPORT:
www.tcl.com
